

**Technical Data Sheet (Preliminary)**  
**Side View LEDs****97-22/BHC-AS1T2****Features**

- White package.
- Dual-chip, wide-angle, low-profile LEDs .
- Excellent chip to chip consistency
- Super Intensity
- Highperformance
- Pb-free.
- The product itself will remain within RoHS compliant version.

**Applications**

- Automotive: backlighting in dashboard and switch.
- Telecommunication: indicator and backlighting in telephone and fax.
- Indicator and backlight for audio and video equipment.
- Indicator and backlight for battery driven equipment.
- Display Screen Illumination on Portable Handheld Devices
- Indicator and backlight in office equipment.
- General use.

**Device Selection Guide**

Chip	Emitted Color	Resin Color
Material		
InGaN	Blue	Water Clear

**Technical Data Sheet (Preliminary)**  
**Side View LEDs**

**97-22/BHC-AS1T2**

**Package Dimensions**

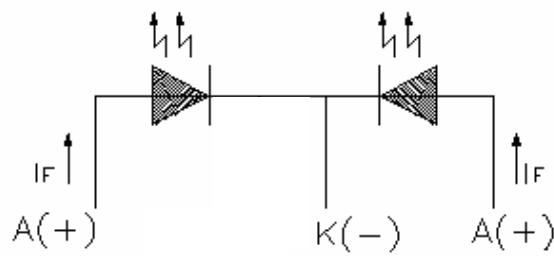
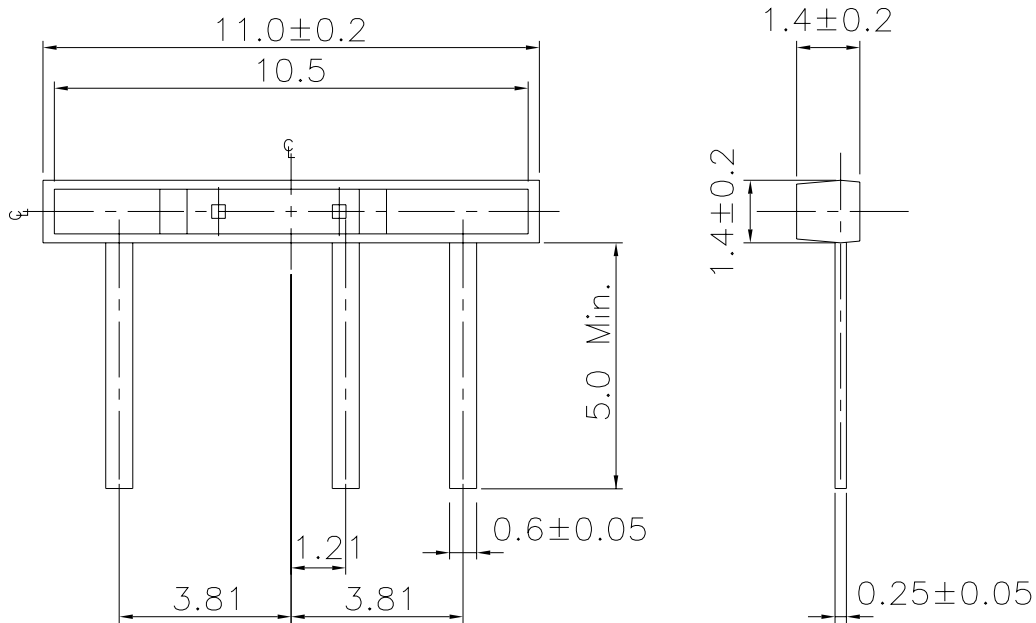

Polarity

**Note:** The tolerances unless mentioned is  $\pm 0.1$ mm ;Unit = mm

## Technical Data Sheet (Preliminary)

### Side View LEDs

#### 97-22/BHC-AS1T2

#### Absolute Maximum Ratings (Ta=25°C)

Parameter	Symbol	Rating	Unit
Reverse Voltage	V <sub>R</sub>	5	V
Forward Current	I <sub>F</sub>	25	mA
Peak Forward Current (Duty 1/10 @1KHz)	I <sub>FP</sub>	100	mA
Power Dissipation	P <sub>d</sub>	110	mW
Electrostatic Discharge(HBM)	ESD	150	V
Operating Temperature	T <sub>opr</sub>	-40 ~ +85	°C
Storage Temperature	T <sub>stg</sub>	-40 ~ +90	°C
Soldering Temperature	T <sub>sol</sub>	Reflow Soldering : 260 °C for 10 sec. Hand Soldering : 350 °C for 3 sec.	

#### Electro-Optical Characteristics (Ta=25°C)

Parameter	Symbol	Min.	Typ.	Max.	Unit	Condition
Luminous intensity	I <sub>v</sub>	180	-----	450	mcd	I <sub>F</sub> =20mA
Viewing Angle	2θ <sub>1/2</sub>	-----	145	-----	deg	I <sub>F</sub> =20mA
Peak Wavelength	λ <sub>p</sub>	-----	468	-----	nm	I <sub>F</sub> =20mA
Dominant Wavelength	λ <sub>d</sub>	464.5	-----	476.5	nm	I <sub>F</sub> =20mA
Spectrum Radiation Bandwidth	Δλ	-----	35	-----	nm	I <sub>F</sub> =20mA
Forward Voltage	V <sub>F</sub>	-----	3.3	3.7	V	I <sub>F</sub> =20mA
Reverse Current	I <sub>R</sub>	-----	-----	50	uA	V <sub>R</sub> =5V

#### Notes:

1. Tolerance of Luminous Intensity ±11%
2. Tolerance of Dominant Wavelength ±1 nm
3. Tolerance of Dominant Forward Voltage ±0.1V

**Technical Data Sheet (Preliminary)****Side View LEDs****97-22/BHC-AS1T2****Bin Range Of Dominant Wavelength**

Group	Bin Code	Min.	Max.	Unit	Condition
A	A9	464.5	467.5	nm	I <sub>F</sub> =20mA
	A10	467.5	470.5		
	A11	470.5	473.5		
	A12	473.5	476.5		

**Bin Range Of Luminous Intensity**

Bin	Min	Max	Unit	Condition
S1	180	225	mcd	I <sub>F</sub> =20mA
S2	225	285		
T1	285	360		
T2	360	450		

**Notes:**

1. Tolerance of Luminous Intensity  $\pm 11\%$
2. Tolerance of Dominant Wavelength  $\pm 1$  nm

**Technical Data Sheet (Preliminary)**  
**Side View LEDs**

**97-22/BHC-AS1T2**

**Typical Electro-Optical Characteristics Curves**

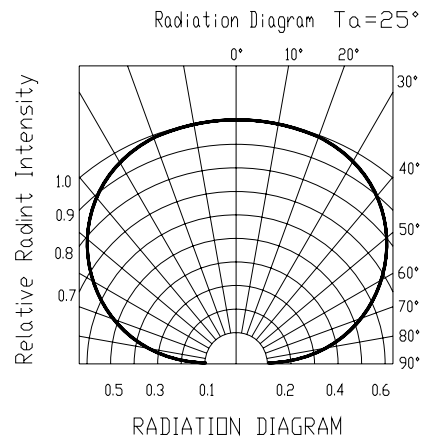
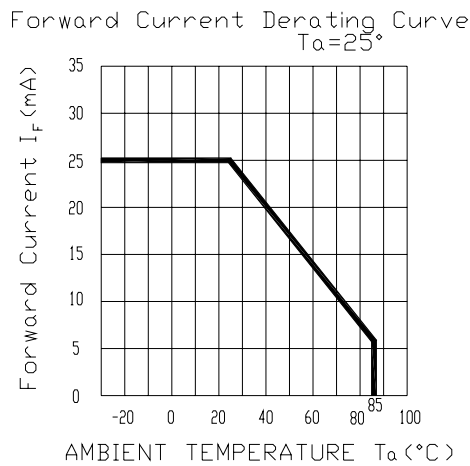
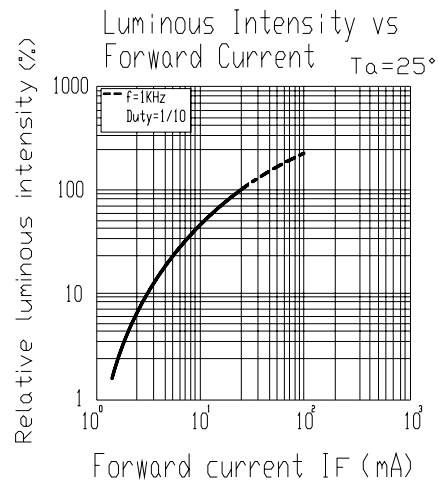
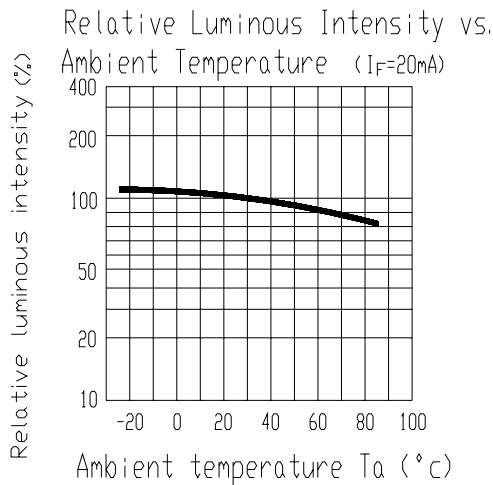
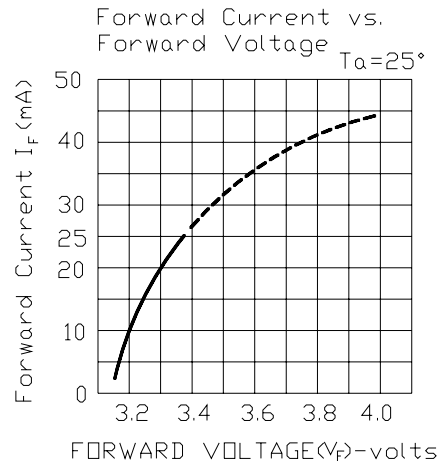
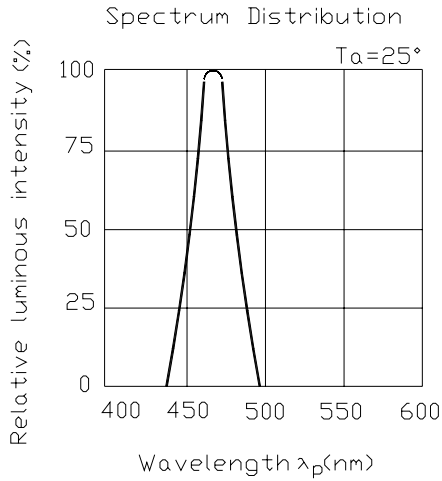



Technical Data Sheet (Preliminary)
Side View LEDs

97-22/BHC-AS1T2

Label explanation

CAT: Luminous Intensity Rank

HUE: Dom. Wavelength Rank

REF: Forward Voltage Rank

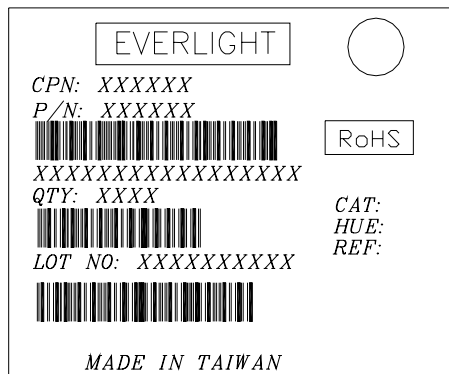

Reliability Test Items And Conditions

The reliability of products shall be satisfied with items listed below.

Confidence level : 90 % LTPD : 10 %

Table with 6 columns: No., Items, Test Condition, Test Hours/Cycles, Sample Size, Ac/Re. It lists 7 test items including Soldering Heat, Temperature Cycle, Thermal Shock, High Temperature Storage, Low Temperature Storage, DC Operating Life, and High Temperature / High Humidity.

**Technical Data Sheet (Preliminary)**  
**Side View LEDs****97-22/BHC-AS1T2****Precautions For Use**

## 1. Over-current-proof

Customer must apply resistors for protection, otherwise slight voltage shift will cause big current change ( Burn out will happen ).

## 2. Storage

2.1 Do not open moisture proof bag before the products are ready to use.

2.2 Before opening the package: The LEDs should be kept at 30°C or less and 90%RH or less.

2.3 After opening the package: The LED's floor life is 1 year under 30°C or less and 60% RH or less.

If unused LEDs remain, it should be stored in moisture proof packages.

2.4 If the moisture absorbent material (silica gel) has faded away or the LEDs have exceeded the storage time, baking treatment should be performed using the following conditions.

Baking treatment : 60±5°C for 24 hours.

## 3.Soldering Iron

Each terminal is to go to the tip of soldering iron temperature less than 350°C for 3 seconds within once in less than the soldering iron capacity 25W. Leave two seconds and more intervals, and do soldering of each terminal. Be careful because the damage of the product is often started at the time of the hand solder.

**EVERLIGHT ELECTRONICS CO., LTD.**  
Office: No 25, Lane 76, Sec 3, Chung Yang Rd,  
Tucheng, Taipei 236, Taiwan, R.O.C

Tel: 886-2-2267-2000, 2267-9936  
Fax: 886-2267-6244, 2267-6189, 2267-6306  
<http://www.everlight.com>